



Liniar Window

installation guide





This installation guide is designed to show you the best way to fit Liniar windows, and covers all styles of window made from Liniar's lead-free 70mm PVCu profile.

Not all window systems are the same and because of its installer friendly design, we recommend you read this guide before fitting your first Liniar window.

Survey and Installation

Installation must comply with all elements of BS8213-4 Code of Practice for the survey and installation of windows and external doorsets.

There should be a solid structure to fix the frame jambs to, and there must be a lintel above the frame aperture.

No load is to be transferred to any part of the frame.

Firstly, when measuring and surveying windows ensure that you allow the required expansion gap around the perimeter of the frame.

For the purpose of this installation guide, the surveyors have allowed the correct tolerance of 5mm all around.

Care must be taken to check that the structure is secure and it is safe to remove the existing window.

It is good practice to measure both internally as well as externally to determine the plaster reveal thickness and

to take note that some apertures may not be square, plumb and level, therefore take sizes from a number of points across the width and height to determine the tightest point. It is advisable to also take a diagonal measurement to assess the squareness of the aperture.

Carry out a pre-installation risk assessment to identify and reduce the risk from any potential hazards.



Step by Step guide

It is good practice to double check manufactured sizes and styles when you arrive on site before you begin to remove the existing window.

Remove the existing window and prepare the area

1 Run a sharp blade around the perimeter of the old window, both internally and externally, to break the seal between the frame and plaster.

2 Remove as much of the glazing as possible and unscrew and remove any sashes.

3 Remove the window and clean off any old sealant and debris from around the opening, removing any loose mortar.

! When removing timber windows/doors it is likely that these will have to be cut to aid their removal. Glass may have to be carefully removed by cutting from glazed apertures.



Prepare the cill

- 4** Cut the cill 200mm greater than the window frame and form a horn around the external face of the brick to give a traditional timber look.

Alternatively, the cill can be square cut to the width of the window frames in some applications.

- 5** Fit the cill end caps using super glue and activator to secure them.

- 6** Run a bead of silicone along the cill upstand prior to fixing it to the window or fit LAN102

Glazing Flipper to 85mm, 150mm or 180mm cills to create a weather tight barrier.

- 7** Secure the cill to the bottom of the window frame using appropriate PVC screws.

- !** Make sure that the screws do not break into the internal glazing rebate.

- 8** Seal the ends of the cill and frame assembly with silicone.

NB: Additional note regarding foiled cills - particularly darker colours. Linar recommends the venting of cills by drilling a 6mm hole on the underside of each chamber and approx 600mm apart along the length of the cill to allow air movement - this means air will not get trapped in the cill and heat up, causing distortion.



Fit the frame

9 Place the new frame into the opening, making sure it's central. Use packers all around the frame checking it's level, square and plumb and that the 5mm expansion gap is maintained.

10 Double check that the frame is plumb, level and square before drilling fixing holes for the sides of the frame, no closer than 150mm from the bottom and top corners and 600mm centres in between

There should be a minimum of two fixings per side, in accordance to industry codes of practice.

! Ensure the cill is located on a solid base so not to cause distortion.

As Linar windows do not contain steel reinforcement, it isn't necessary to apply as much force when drilling.

! If interlocking wedges are in place, take care to ensure that the frame isn't twisted and that packers are positioned to support the frame.

11 Fix the sides of the frame to the wall using nylon sleeve frame anchors, self-tapping masonry screws or other suitable fixings to match the aperture and surrounds.

12 Packers need to be positioned between the frame and the brickwork at all of the fixing points to maintain the 5mm expansion gap. It is important that packers bridge the full width of the frame to prevent distortion.



13 Directly fix the top and bottom of frames over 1200mm in width in accordance with industry codes of practice to stop deflection in adverse conditions.

14 Use silicone in and around the holes that have been drilled through the bottom of the frame before inserting the screws - this prevents water ingress.

! Remember, packers should be placed adjacent to the fixings to maintain the 5mm expansion gap and prevent distortion.

15 In preparation for sealing, break off the excess length of the packers with a chisel.

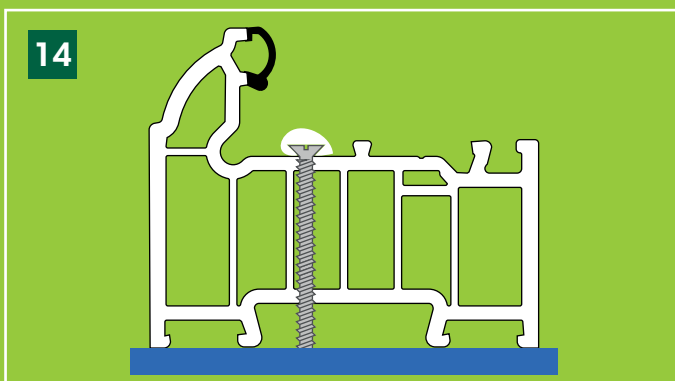

Fit the glass

16 Clean any brick dust or debris from the frame and surrounding areas before fitting the glazing.

17 Remove the beads taking note of their positions. Place glazing platforms into place around the opening before you begin glazing the frame. Platforms are an integral component that contribute to the structural performance. See page 9.

! Note that where opening casements are hinged from the side they need to be 'toed and heeled' which means the glass is

packed at diagonally opposing corners, at the bottom on the hinge side and top on the handle side, holding the casement square. See page 9.

18 Install the glass, ensuring a tight fit against the glazing platforms. Additional glazing packers can be used to lift the sash to the required height to ensure ease of use and allow visual alignment and an equal seal around the frame

! It is worth noting that the 'toe and heeling' process transfers the weight of the glass to the bottom hinges and allows the top hinge to hold the sash in place.

19 Make sure that the unit is pushed right back into the glazing seal using the glazing shovel.



Glazing platform positioning

All glazing must fall in line with the requirements of BS6262 and any recommendations of the glass manufacturers.

The correct use of glazing platforms is critical to allow windows to function correctly. The diagrams below show the correct position of the glazing platforms.

It is essential that the glass stays in position and we therefore recommend that where necessary the platforms are siliconed into place. Ensure that all platforms do not obstruct any drainage holes.

■ Load bearing platforms must be used to keep window square and level.

■ Bracing platforms to prevent glass movements and provide rigidity to the window.

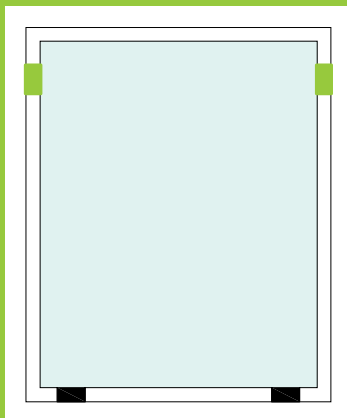

Fixed

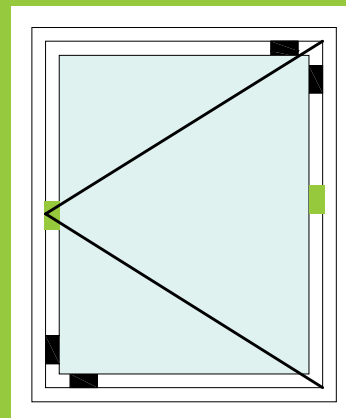

Side Hung

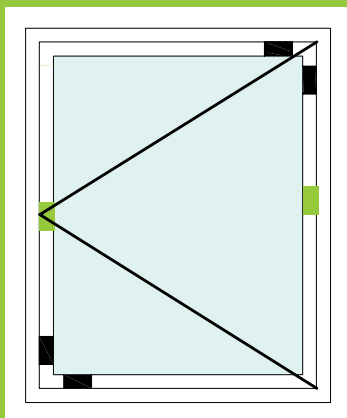

Tilt & Turn

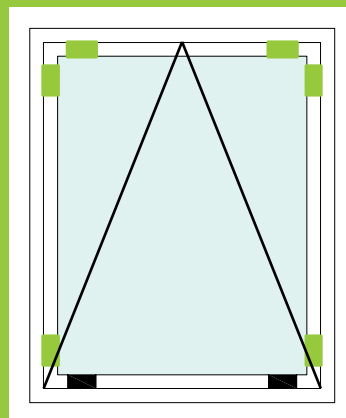

Top Hung

Beading and finishing

20 Always start with the smaller beads first. To help locate the beads, spray glass cleaner around the edges of the glass.

21 Starting at the corner, locate the back of the bead into the groove and tap it into place with a nylon mallet, keeping pressure against the glass.

Continue this with the opposite bead next and then the two final ones. Ensure mitre joints are pushed tight together to achieve optimum finish.

22 Once all of the panes are fitted, clean the frame and glass to remove dust.

Run a strip of masking tape around the perimeter of the frame and internal wall in preparation for sealing.

23 To allow for redecoration, use a Liniar Approved acrylic sealant or decorator's caulk.

Once all four sides have been sealed, peel away the protective tape before the sealant sets for a neat, clean finish.

This completes the internal work.

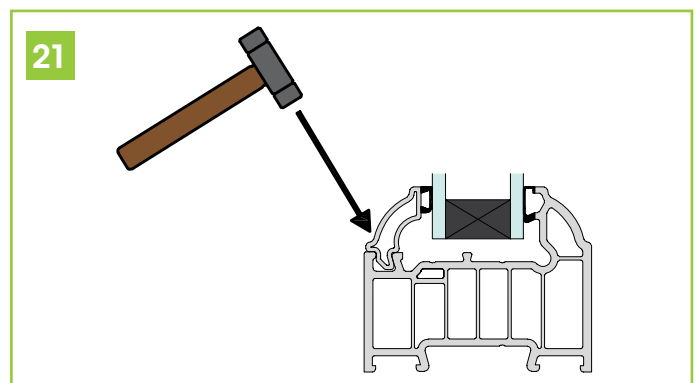

External finishing

24 Ensure all dust and grit is removed from the external surfaces then apply a strip of masking tape to the frame perimeter.

25 Apply a smooth bead of silicone sealant between the frame and brickwork.

Remove the masking tape before the sealant sets for a neat, clean finish.

26 Don't forget to seal below the external cill.

27 Check that the correct compression and function is achieved on the window and make any adjustments required.



Perform final checks and handover

28 Clean the debris away from your working area.

29 Remove the protective tape from the window and cill.

Clean the frame with PVCu cleaner or warm soapy water.

The installation is now complete.

30 Show the customer the correct way to operate the windows.

31 Hand over the Liniar maintenance guide and guarantee certificate. These can be downloaded from the installer centre on the Liniar website.

Don't forget to take photographs of your work to submit to Liniar.

Send them to us either via twitter @liniarprofiles or to by email to marketing@liniar.co.uk.



De-glazing

- 1** Insert the edge of a tool with a fine edge, such as a putty knife, between the bead and the frame – starting with the longest bead.

Forcing it into position, lever the bead away from the glass.

- 2** Once you've gained some clearance, push the tool in behind the bead and slide it up against the frame of the bead without touching the glass.

You will then be able to remove the bead.

- !** Make a note of the bead positions that you have removed so that you can place them back in their original positions.

- 3** Repeat the process on all four beads and work your way around the edge.

- 4** Remove the glass by levering the glazing shovel around the pane to loosen it, then carefully using a suitable glass sucker to lift out the unit.



Bay Pole Assembly

1 Prepare the cill platform by locally removing the upstand to allow for the corner post at the welded joint.

2 Align top spreader plate with front edge of cill and mark drill hole centre.

3 Drill a 22mm diameter hole through the cill.

4 Locate jack base from underside of the cill and screw in adjustment platform from top side.

5 Assembly top and bottom spreader plates with aluminium bay post and position onto jack.

6 Adjust the jack until the top spreader plate is tight up against the head of the building reveal and ensure that the aluminium post is plumb/vertical.

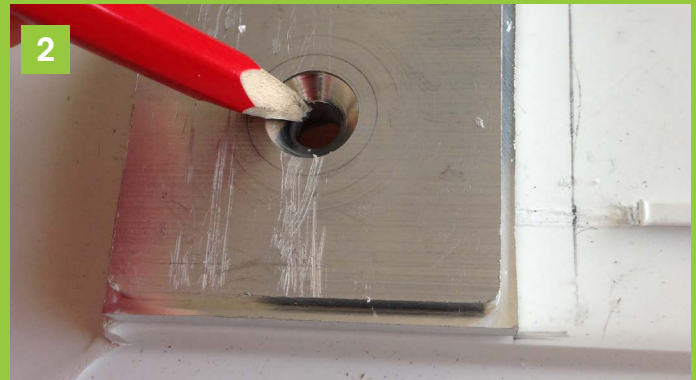

7 Mark position of the top spreader plate and then remove aluminium post by lowering the jack.

8 Secure top spreader plate at the marked position to the reveal head using appropriate fixings.

9 Prepare the bottom of the PVCu square post cover on face by removing a 55mm x 40mm areas and slide aluminium post into the cover.

10 Assembly aluminium post and PVCu cover onto Jack and adjust until the aluminium post is located onto the top spreader plate.

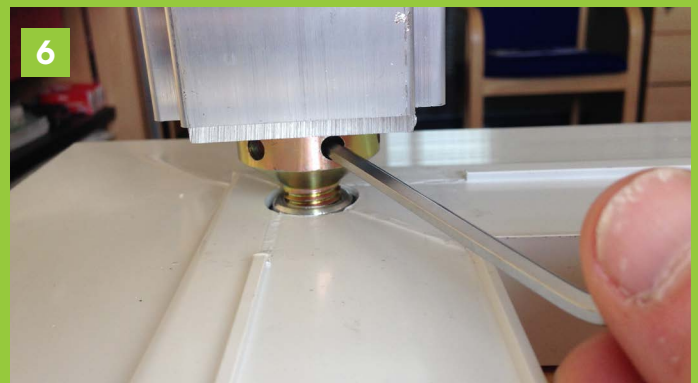

7 great reasons to choose Liniar

Innovative – the only entirely new PVCu window and door profile system to be developed in the last 10 years

Energy efficient – designed from scratch to achieve the pinnacle of thermal performance and retain more heat in your property

Safe and secure – engineered with built-in security features and approved by independent testing facilities

British made – manufactured in our state-of-the-art factory in the heart of Derbyshire

Lead free – all Liniar profiles are extruded using materials that are 100% lead free

Quality assured – backed with ISO 9001 accreditation for your peace of mind

Guaranteed – all Liniar frames are guaranteed to not warp, split or discolour for a minimum of 10 years

