

Classic
HERITAGE DOOR
Installation Guide



PART L Compliant ✓

Contents

p3 **SURVEY**

Survey & Pre-Installation	3
---------------------------	---

p4 **WINDOW INSTALLATION**

Cill Preparation	4
Frame Fitting	5
Glazing Openers and Dummy Sashes	6
External Finishing & Final Checks	7

p8 **OPTIONAL**

Dummy Sash Removal	8
Fixed Pane Removal	9
Dummy Sash Fitting Instructions	10
Bead Removal / Frame Extenders	11
Fit Door Restrictor	12
Video Links	13

Survey & Pre-Installation

Check the aperture to make sure there is no loose plaster or brickwork, and that it is free of any debris or brick dust. Ensure that a solid, level base is present at the required dimensions and can provide packing points at 250mm centres and fixing points at 600mm centres. Ensure floor levels do not obstruct door operation or impede drainage.

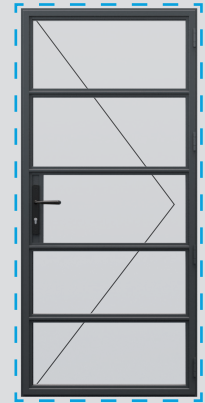

1.

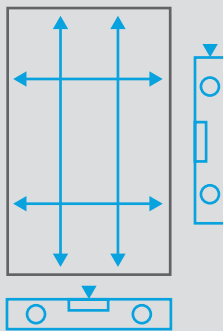

Ensure that all four sides of the aperture are plumb and square and identify any potential packing points.

Please note our recommended fixing positions are into the outer wall, and that frames are not fixed over an open cavity as this can compromise system performance.

2.

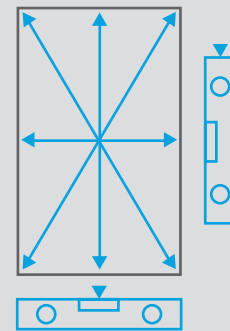

Ensure an adequate lintel or head linings are present, and are level and capable of supporting both the construction above and the door itself. Check the cill is level and provides a solid base.

Note: The door should be packed under the jambs to provide sufficient support.

Check for alignment at points shown.

Frame size = brick-to-brick size – 5mm each side, to allow for level and square installation.

Disclaimer: Please check with the latest Building Regulations and standards that are relevant to your area for guidance and to ensure you comply with the latest regulations. The advice given in this document assumes fitting will be carried out by a qualified professional following BS 8213 - 4:2016 the Code of Practice for the Survey and Installation of Windows and External doorsets, where applicable.

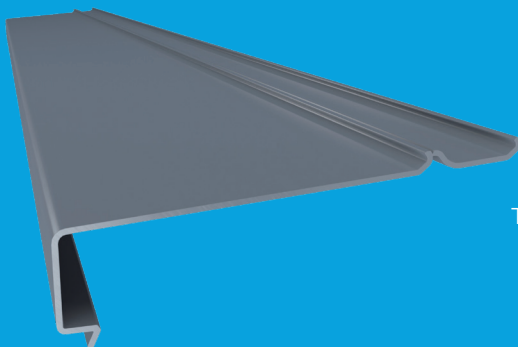

Cill Protector

SA516 Reusable Cill Protectors are available from Sheerline. These help prevent damage on renovations and new-builds where building work will continue after the doors have been installed.

Cill Preparation (If required)

The cill can either be cut square to the width of the door, or cut with an additional 100mm on either side to form a traditional horn around the brickwork.

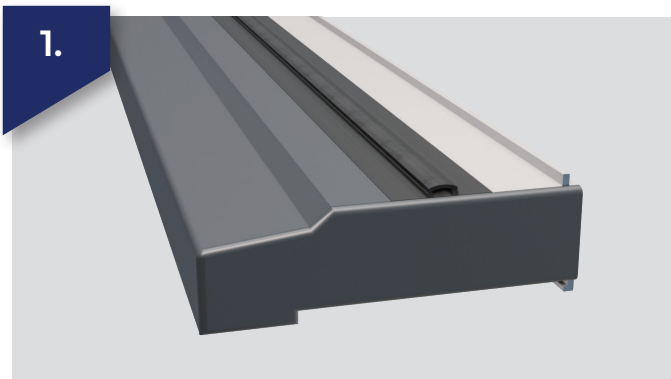
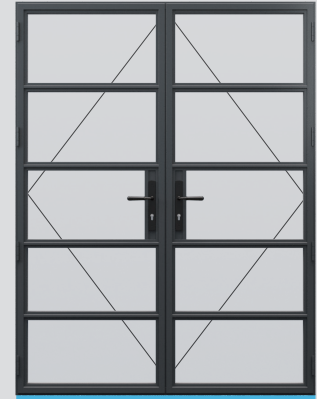

Secure end caps to the cill using a suitable superglue and activator.

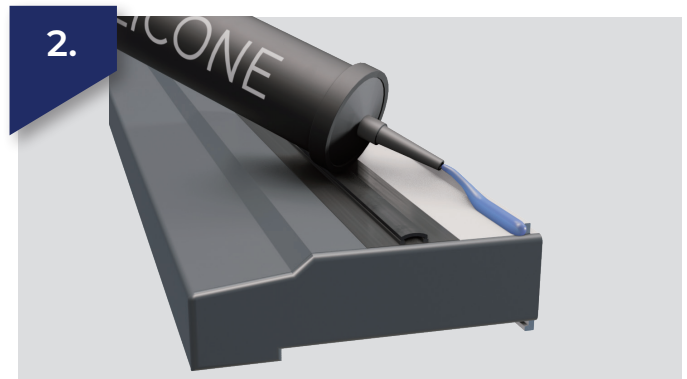

A co-extruded gasket on the cill, seals between the frame and cill along its length. Also apply a bead of silicone sealant along the inner edge of the upstand.

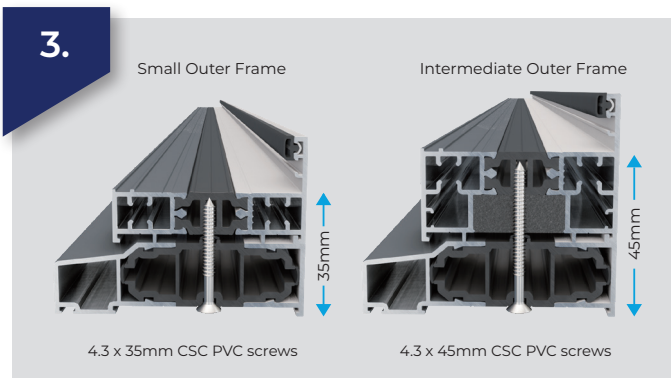

Fix through the cill into the door frame using countersunk PVC-U screws, taking care that they do not break into the internal frame area. Fix 150mm from the ends and at max 300mm centers. Ensuring a minimum of 3 fixings.

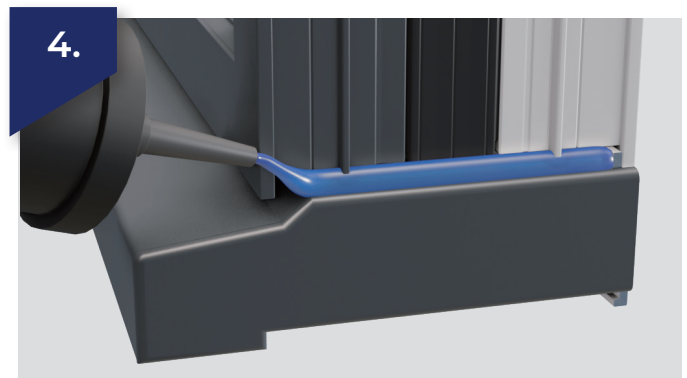

Seal with silicone along the edge where the cill meets the frame.

Frame Fitting

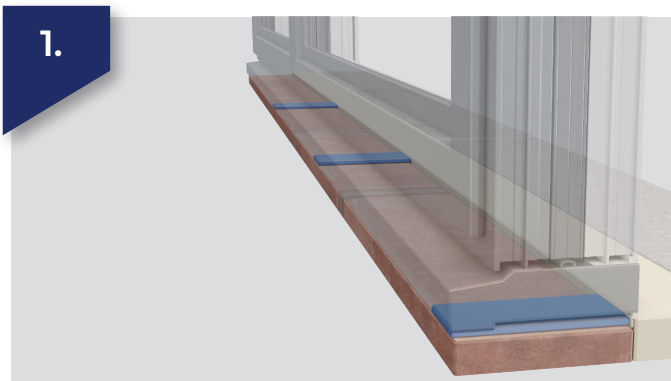
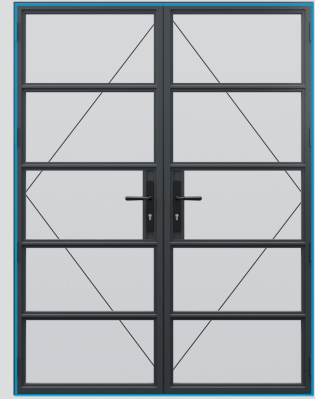

1. Pack under the cill and door jambs and seal along the aperture bottom in preparation for installation. It is good working practice to set the outer frame 30mm in from the front face of brickwork. Pack under each fixing point.

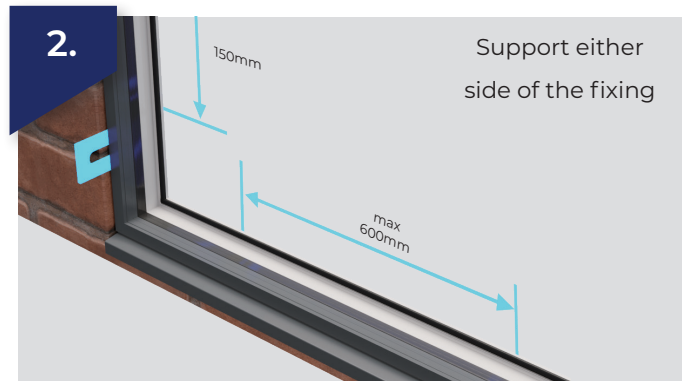

2. Pack around the frame using full-width packers ensuring that it's square and level, and ensure a 5mm gap is maintained. Drill pilot holes around the frame at min 150mm from corners and max 600mm centres in between.

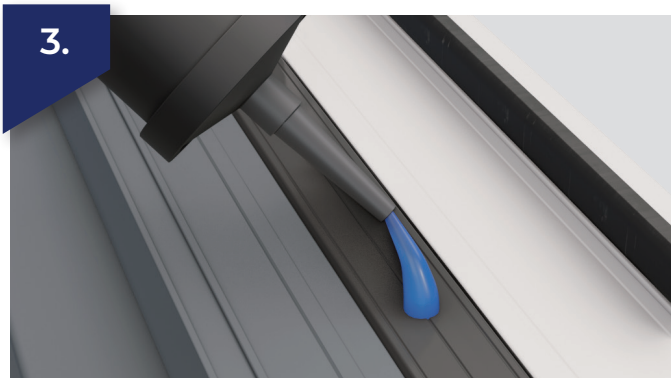

3. Prior to fixing the frame, seal the holes in the bottom of the frame to prevent water ingress.

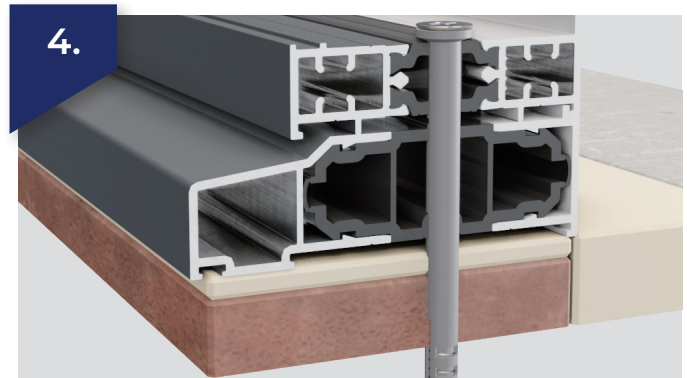

4. Fix the frame into the aperture using suitable frame fixings to suit construction material. Countersinking if required.

Glazing Openers and Dummy Sashes

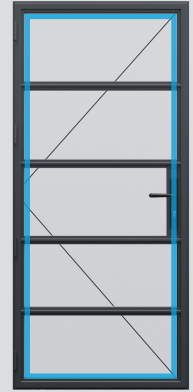

Remove the beads from the door and place them to one side. Beads must be returned to original position once glazed so make a note of where they come from. Ensure all gaskets are inserted into the respective rebates and beads before the glazed unit is fitted.

1.

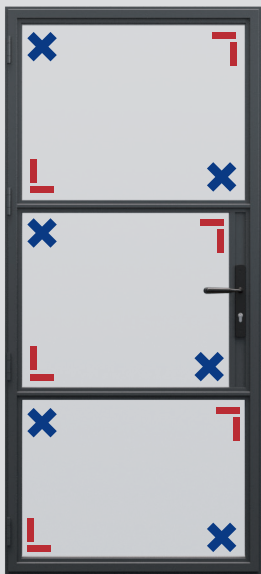

Toe & Heel



Pack square*



Fit the glazed unit into the sash and pack / toe & heel in the appropriate places using glazing packers as shown.

Toe & heeling should distribute the weight of the glass correctly to ensure the door is square and aligned.

Using glass packers at the opposite corners of the sash as shown, creates diagonal support across the glass unit, ensuring the door operates correctly.

*Position packers in line with locking points to meet PAS 24 requirements

2.



Spray the glass unit with a mild soap/water mix or glass cleaner to prevent the gasket sticking while the bead is being fitted.

3.

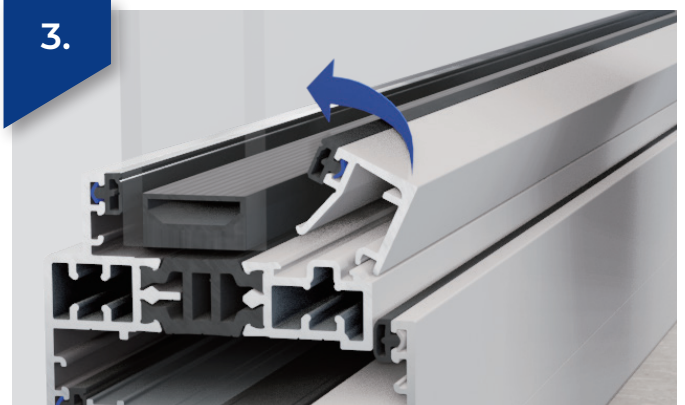

Start by locating the front leg of the bead into the receiving channel and rotate the bead until it 'clips' into place.

Fit the top bead first to secure the unit. Continue by fitting the bottom bead and then the sides, being careful not to scratch the powder coated finish.

If the gasket is not seated correctly, use a glazing shovel to gently press the gasket into the bead to give a nice smooth finish.

External Finishing & Final Checks

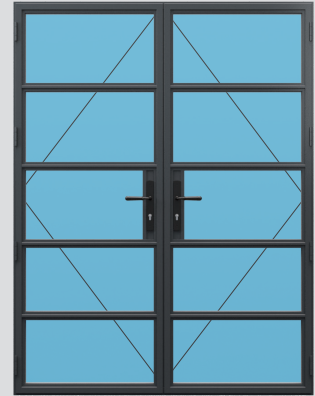

1.

Break off any protruding packers where necessary.

2.

Remove protective tape from all profiles. Clean down aluminium and glass with warm, soapy water.

3.

Expanding foam can be used to fill any large apertures around the frame. Be careful not to overfill. Now trim or silicone around outer frame and seal below external cill if applicable.

4.

Check the door for correct function.

5.



If you need to adjust the compression on door sashes, to ensure they open with minimal effort, but maintain a tight seal when closed. You can increase the contact pressure between the sash and frame as required by using the two machine screws indicated.

6.



Adjust the latch plate. Backwards or forwards as shown. Then re-tighten the machine screws.

Dummy Sash Removal

(Using Dummy Sash Packers)

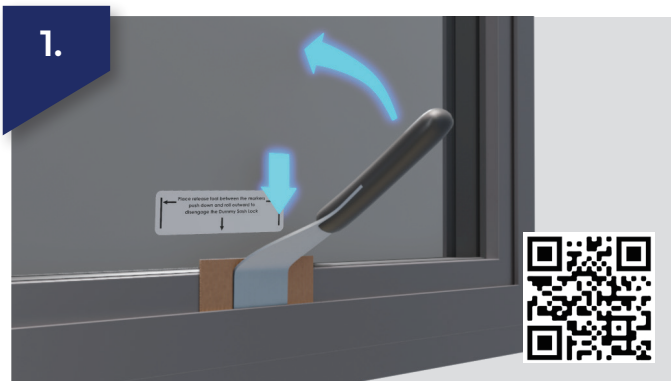
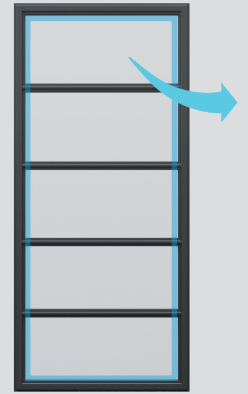

1. If already fitted, release the sash by locating the dummy sash packer using the release tool. Press down firmly onto the paddle plate before rolling forward onto the sash to disengage the lock, ensuring you have put protective padding in place to protect the sash.

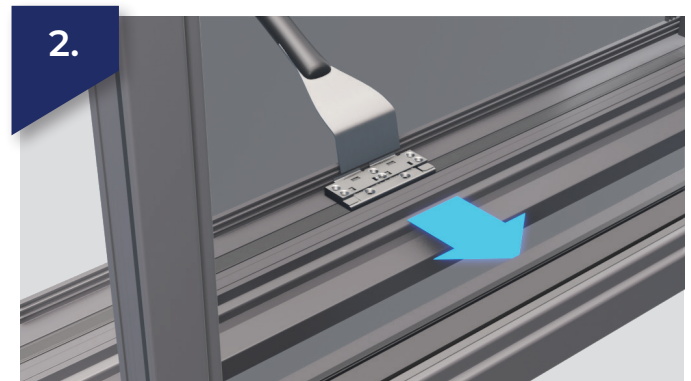

2. Please Note: the lock can be reengaged at any time to resecure the dummy sash in position.



3. Make sure you have a safe and protected surface to lay the dummy sash once you've removed it. Start by unscrewing the sash.



4. Holding the sash securely, tilt the hinges away from the corner hinge locators and lift out.

Fixed Pane Removal

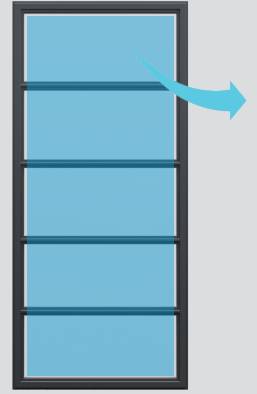

1. Place the de-glazing tool under the sealed unit to the back of the window section as shown. Then slide the de-glazing tool to the left / right until it meets the Securi-clip and pull towards you.

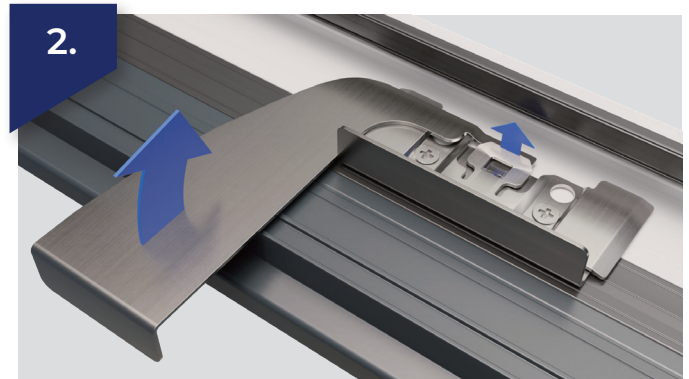

2. Lift the de-glazing tool to engage between the base unit and securi-clip.

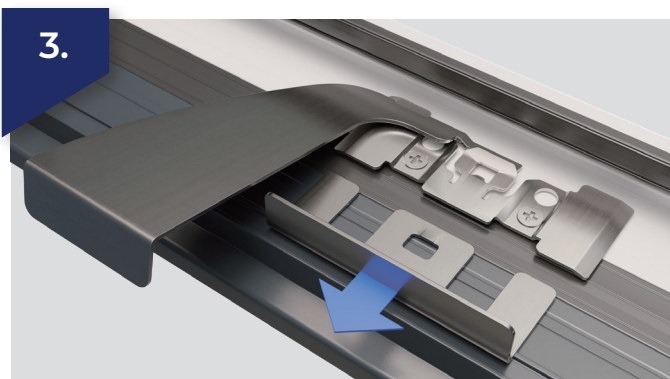

3. Place the handle part of a second de-glazing tool between the clip and the glass and pull the clip out as shown.

Dummy Sash Fitting Instructions

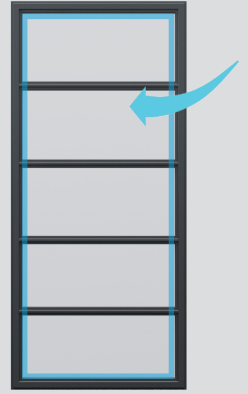

Clear the frame of any debris before fitting the sashes.

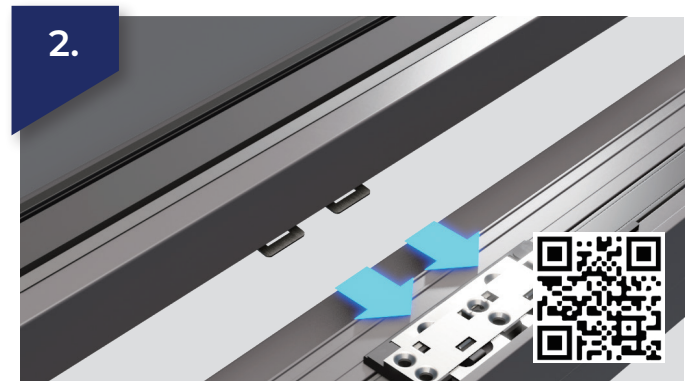

If not already fitted:
The dummy sashes should be supplied with a two-pronged device. This is usually taped to the window, along with packing pieces and fixing screws. These are installed underneath the odd leg of the sash and the holes should have been predrilled.

Check that the gap between the sash and the outer frame is consistent from left to right and that everything is parallel. Now push firmly closed.

IMPORTANT NOTE: ensure the packer is used (highlighted above), so that the sash can be removed later if necessary.

Bead Removal

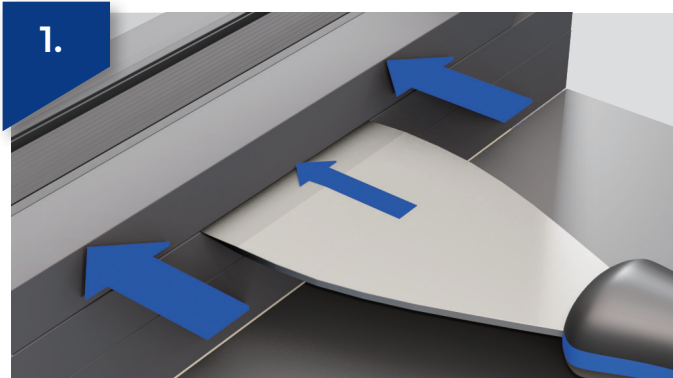

1. Press the top edge of the bead toward the glass, creating a gap between the bead and the frame/ sash.



2. Using a thin pallet knife or appropriate tool, insert the tool in the gap created and lever away from the bead to disengage from the fixed profile.

Frame Extenders

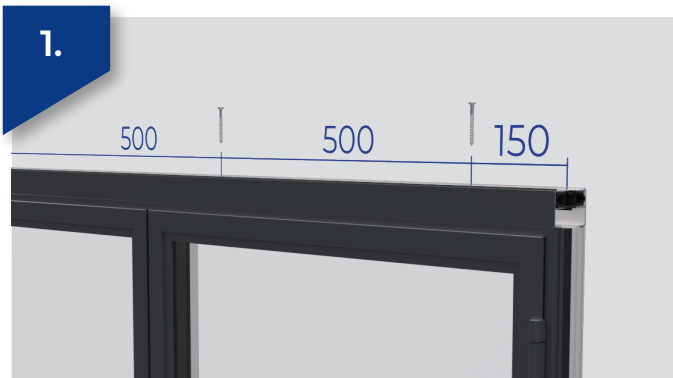

1. Fix frame extender 150mm from ends and max 500mm between centres using 4.3 x 55mm countersunk screws (or 4.3 x 35mm countersunk screws if the extender is flipped with the thermal break against the frame)

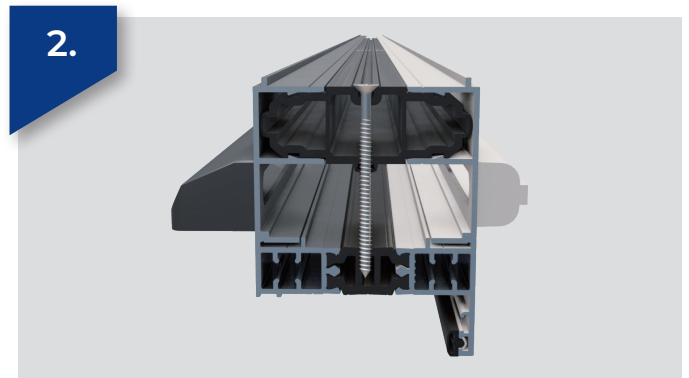

2. Fix as above to ensure the screws will not break through into the door track.

Fit Door Restrictor

1.

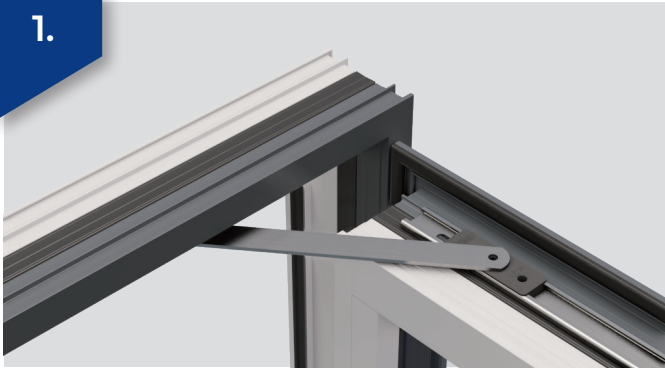

Locate datum bar against sash insert and screw the door restrictor into position on the sash using four 3.9mm x 16mm pan head self drilling screws.

2.



Locate position at the hinge end of the sash head.

Video Links

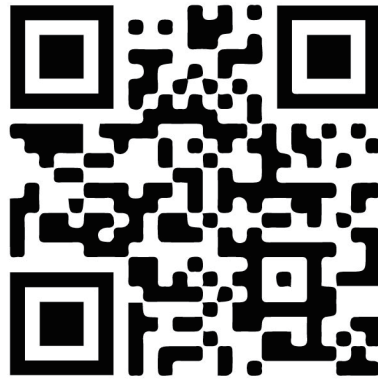

Dummy Sash Lock
Fabrication & Operation

Please send any photos of your installation to
info@sheerline.com so we can share your work.

Or tag us on social media:



LINKEDIN
/sheerlinesystem



FACEBOOK
/SheerlineSystem



INSTAGRAM
@sheerlinealuminium



X
@SheerlineSystem



www.sheerline.com

